

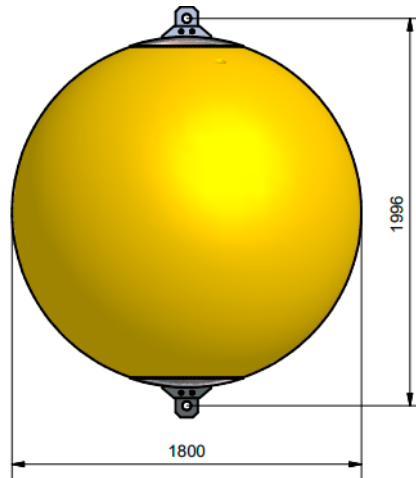

Medidas:

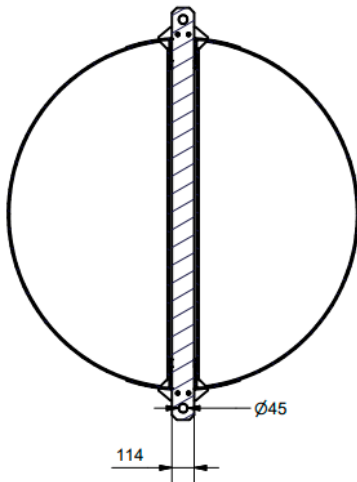

Diámetro: 199,6 cm
Largo: 180 cm









CARACTERÍSTICAS

Volumen total 3000 L
Fabricada en Polietileno HMWHDPE
Espesor promedio 7 mm
Polietileno de alta resistencia
Limite elástico 25 Mpa

Inyectado con AIRE
Componentes metálicos galvanizado en caliente
Tiro a ruptura superior a 50 Ton

POLYCHEM SANTIAGO

 (2) 2 4209220
 (2) 2 4209221
 +56 9 7848 0440
 +56 9 7814 9629
 ventasantiago@polychem.cl
 San Eugenio 12451, San Bernardo
Santiago – Chile

POLYCHEM PUERTO MONTT

 +56 65 227 5845
 ventassip@polychem.cl
 Ruta 226 Km 9,6
Camino aeropuerto
Pto Montt – Chile



VISÍTENOS EN:
 <https://www.polychem.cl>